

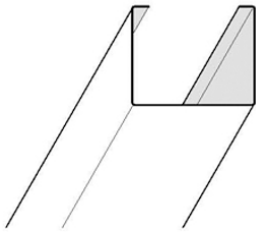

DAMPA Interval

DAMPA's Interval Program gives the ceilings a minimalist look. The open space between the panels can be varied, which can create a large width in relation to the design and function of the ceiling.





Dimensions without end-closure

- ITV 40x30x40
- ITV 60x30x60
- ITV 100x30x100
- ITV 50x50x50
- ITV 40x55x40

Dimensions with end-closure

- ITV 40x155x40
- ITV 40x255x40

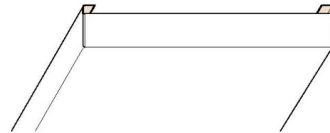

Suspension System

All panel types are hooked to the carrier rails without tools, and each unit can be de- and reinstalled separately. The support rails are as standard painted black.

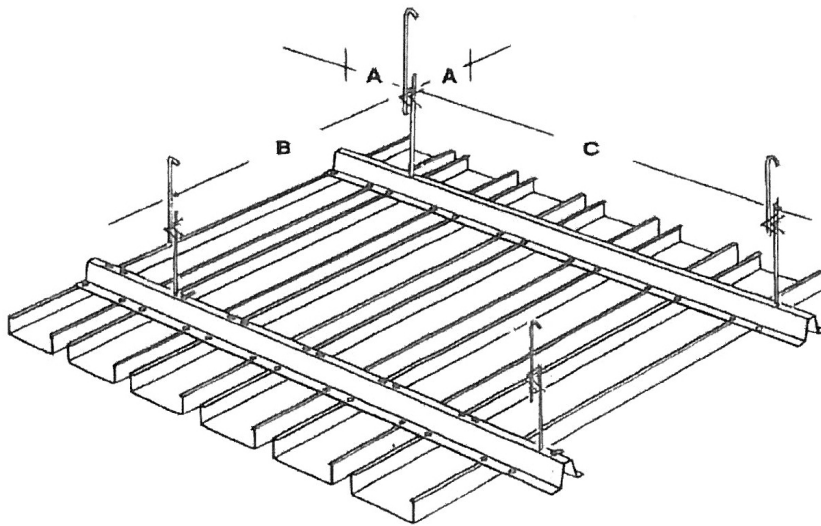

Maximum distances

A: 300 mm B:1200 mm C:1800 mm

Module Mounting rail nr. 37

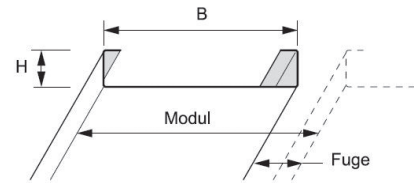
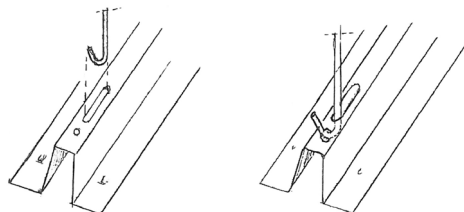
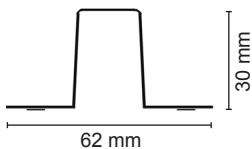

Module size

Support rails for each interval types are available with variable clamping range. Module size is the width of the panel + joint.

Color

Color and gloss level allows for the ceiling surface to become a part of the interior design.

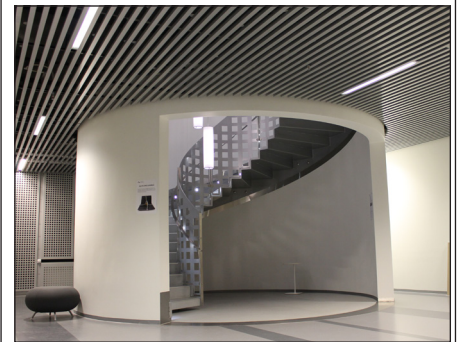

Integrated System

Light and ventilation are integrated in the ceiling for installation of specially designed fixtures that are adapted in shape and color.

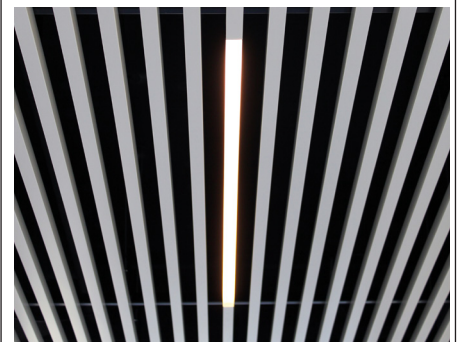

Quality

The panels are manufactured in accordance with quality management systems, DS / EN / ISO 9001:2008.



Made in Denmark